

# E4981A Capacitance Meter



## Table of Contents

Definitions and Specifications .....	03
Definitions .....	03
Basic specifications .....	03
Specifications .....	04
Measurement .....	04
Supplemental Information .....	20
Measurement Assistance Functions .....	24
General Specifications .....	27
EMC, Safety, Environment and Compliance .....	30
Sample Calculation of Measurement Accuracy .....	32

## Definitions and Specifications

This document provides specifications and supplemental information for the Keysight Technologies, Inc. E4981A capacitance meter. All specifications apply to the conditions of a 0 °C to 45 °C temperature range, unless otherwise stated, and 30 minutes after the instrument has been turned on.

### Definitions

**Specification (spec.):** Warranted performance. Specifications include guard bands to account for the expected statistical performance distribution, measurement uncertainties, and changes in performance due to environmental conditions.

Supplemental information is intended to provide information that is helpful for using the instrument but that is not guaranteed by the product warranty.

**Typical (typ.):** Describes performance that will be met by a minimum of 80% of all products. It is not guaranteed by the product warranty.

**Nominal (nom.):** A general descriptive term that does not imply a level of performance.

**Option dependencies**

The available frequency is defined as follows.

E4981A-001: 120 Hz/1 kHz/1 MHz/1 MHz  $\pm$  1%/1 MHz  $\pm$  2%  
E4981A-002: 120 Hz/1 kHz

The information regarding “Frequency 1 MHz/1 MHz  $\pm$  1%/1 MHz  $\pm$  2%” in specifications, supplemental and general information is not valid for the E4981A-002.

### Basic specifications

**Measurement parameters**

- Cp-D, Cp-Q, Cp-Rp, Cp-G
- Cs-D, Cs-Q, Cs-Rs

where

Cp: Capacitance value measured using the parallel equivalent circuit model

Cs: Capacitance value measured using the series equivalent circuit model

D: Dissipation factor

Q: Quality factor (inverse of D)

G: Equivalent parallel conductance measured using the parallel equivalent circuit model

Rp: Equivalent parallel resistance measured using the parallel equivalent circuit model

Rs: Equivalent series resistance measured using the series equivalent circuit model

# Specifications

## Measurement

### Measurement signals

Frequency	Allowable frequencies	120 Hz
		1 kHz
		1 MHz
		0.98 MHz (1 MHz - 2%)
		0.99 MHz (1 MHz - 1%)
		1.01 MHz (1 MHz + 1%)
		1.02 MHz (1 MHz + 2%)
	Accuracy	±0.02%
Level	Range	0.1 V to 1 V
	Resolution	0.01 V
	Accuracy	±5%
Output mode	Continuous or Synchronous	
Source delay time <sup>1</sup>	Range	0 to 1 s
	Resolution	0.1 ms

1. Source delay time is effective when output mode is set to Synchronous mode.

Measurement cable lengths: 0 m, 1 m, 2 m

Measurement time selection: 5 speeds measurement time mode N = 1, 2, 4, 6, 8  
For information on the measurement time in each mode, refer to Table 15  
“Measurement time.”

Measurement range selection: Auto, Hold

Measurement range:	Measurement signal frequency:	10 nF	22 nF	47 nF	100 nF
	120 Hz	220 nF	470 nF	1 $\mu$ F	2.2 $\mu$ F
		4.7 $\mu$ F	10 $\mu$ F	22 $\mu$ F	47 $\mu$ F
		100 $\mu$ F	220 $\mu$ F	470 $\mu$ F	1 mF
Measurement range:	Measurement signal frequency:	100 pF	220 pF	470 pF	1 nF
	1 kHz	2.2 nF	4.7 nF	10 nF	22 nF
		47 nF	100 nF	220 nF	470 nF
		1 $\mu$ F	2.2 $\mu$ F	4.7 $\mu$ F	10 $\mu$ F
		22 $\mu$ F	47 $\mu$ F	100 $\mu$ F	
Measurement range:	Measurement signal frequency:	1 pF	2.2 pF	4.7 pF	10 pF
	1 MHz / 1 MHz $\pm$ 1% / 1 MHz $\pm$ 2%	22 pF	47 pF	100 pF	220 pF
		470 pF	1 nF		

For information on measurable range in each measurement mode, refer to  
“Available measurement ranges” (Tables 2 through 4).

Averaging:	Range	1 to 256 measurements
	Resolution	1

Trigger mode:

Internal trigger (Int), Manual trigger (Man), External trigger (Ext),  
GPIB/USB/LAN trigger (Bus)

Trigger delay time:

Range	0 to 1 s
Resolution	0.1 ms

Measurement display ranges

Table 1 shows the range of the measured value that can be displayed on the screen.

Table 1. Allowable measured value display range

Parameter	Measurement display range
Cs, Cp	±1.000000 aF to 999.9999 EF
D	±0.000001 to 9.999999
Q	±0.01 to 99999.99
Rs, Rp	±1.000000 aΩ to 999.9999 EΩ
G	±1.000000 aS to 999.9999 ES
Δ%	±0.0001 % to 999.9999 %

a:  $1 \times 10^{-18}$ , E:  $1 \times 10^{18}$

## Available measurement ranges

Tables 2 through 4 show recommended measurement ranges (recommended for accurate measurement) and significant measurement ranges (ranges that do not cause overload) for each measurement value under the condition D (dissipation factor)  $\leq 0.5$ .

Table 2. Measurable capacitance ranges when measurement frequency is 120 Hz

<b>Measurement range setting</b>	<b>Recommended measurement range</b>	<b>Significant measurement range</b>
10 nF	0 F to 15 nF	0 F to 15 nF
22 nF	15 nF to 33 nF	0 F to 33 nF
47 nF	33 nF to 68 nF	0 F to 68 nF
100 nF	68 nF to 150 nF	0 F to 150 nF
220 nF	150 nF to 330 nF	0 F to 330 nF
470 nF	330 nF to 680 nF	0 F to 680 nF
1 $\mu$ F	680 nF to 1.5 $\mu$ F	0 F to 1.5 $\mu$ F
2.2 $\mu$ F	1.5 $\mu$ F to 3.3 $\mu$ F	0 F to 3.3 $\mu$ F
4.7 $\mu$ F	3.3 $\mu$ F to 6.8 $\mu$ F	0 F to 6.8 $\mu$ F
10 $\mu$ F	6.8 $\mu$ F to 15 $\mu$ F	0 F to 15 $\mu$ F
22 $\mu$ F	15 $\mu$ F to 33 $\mu$ F	0 F to 33 $\mu$ F
47 $\mu$ F	33 $\mu$ F to 68 $\mu$ F	0 F to 68 $\mu$ F
100 $\mu$ F	68 $\mu$ F to 150 $\mu$ F	0 F to 150 $\mu$ F
220 $\mu$ F	150 $\mu$ F to 330 $\mu$ F	0 F to 330 $\mu$ F
470 $\mu$ F	330 $\mu$ F to 680 $\mu$ F	0 F to 680 $\mu$ F
1 mF	680 $\mu$ F to 2 mF	0 F to 2 mF

Available measurement ranges (continued)

Table 3. Measurable capacitance ranges when measurement frequency is 1 kHz

Measurement range setting	Recommended measurement range	Significant measurement range
100 pF	0 pF to 150 pF	0 F to 150 pF
220 pF	150 pF to 330 pF	0 F to 330 pF
470 pF	330 pF to 680 pF	0 F to 680 pF
1 nF	680 pF to 1.5 nF	0 F to 1.5 nF
2.2 nF	1.5 nF to 3.3 nF	0 F to 3.3 nF
4.7 nF	3.3 nF to 6.8 nF	0 F to 6.8 nF
10 nF	6.8 nF to 15 nF	0 F to 15 nF
22 nF	15 nF to 33 nF	0 F to 33 nF
47 nF	33 nF to 68 nF	0 F to 68 nF
100 nF	68 nF to 150 nF	0 F to 150 nF
220 nF	150 nF to 330 nF	0 F to 330 nF
470 nF	330 nF to 680 nF	0 F to 680 nF
1 $\mu$ F	680 nF to 1.5 $\mu$ F	0 F to 1.5 $\mu$ F
2.2 $\mu$ F	1.5 $\mu$ F to 3.3 $\mu$ F	0 F to 3.3 $\mu$ F
4.7 $\mu$ F	3.3 $\mu$ F to 6.8 $\mu$ F	0 F to 6.8 $\mu$ F
10 $\mu$ F	6.8 $\mu$ F to 15 $\mu$ F	0 F to 15 $\mu$ F
22 $\mu$ F	15 $\mu$ F to 33 $\mu$ F	0 F to 33 $\mu$ F
47 $\mu$ F	33 $\mu$ F to 68 $\mu$ F	0 F to 68 $\mu$ F
100 $\mu$ F	68 $\mu$ F to 200 $\mu$ F	0 F to 200 $\mu$ F



Available measurement ranges (continued)

Table 4. Measurable capacitance ranges when measurement frequency is 1 MHz, 1 MHz  $\pm$ 1%, 1 MHz  $\pm$ 2%

Measurement range setting	Recommended measurement range	Significant measurement range
1 pF	0 F to 1.5 pF	0 F to 1.5 pF
2.2 pF	1.5 pF to 3.3 pF	0 F to 3.3 pF
4.7 pF	3.3 pF to 6.8 pF	0 F to 6.8 pF
10 pF	6.8 pF to 15 pF	0 F to 15 pF
22 pF	15 pF to 33 pF	0 F to 33 pF
47 pF	33 pF to 68 pF	0 F to 68 pF
100 pF	68 pF to 150 pF	0 F to 150 pF
220 pF	150 pF to 330 pF	0 F to 330 pF
470 pF	330 pF to 680 pF	0 F to 680 pF
1 nF	680 pF to 1.5 nF	0 F to 1.5 nF

## Measurement accuracy

The measurement accuracy is defined when all of the following conditions are met:

- Warm-up time: 30 minutes or longer
- Ambient temperature: 18 °C to 28 °C
- Execution of OPEN Correction
- Execution of Cable Correction for 1 MHz measurement
- Measurement cable length: 0 m, 1 m, or 2 m (16048A/B/D)<sup>1</sup>
- D (dissipation factor)  $\leq 0.5$

## Basic Accuracy (Typical)

C: 0.042%, D: 0.0003

## Accuracy of Cp, Cs, D, G, Rs, Q and Rp

Tables 8 through 13 show the measurement accuracy of Cp, Cs, and D when  $D \leq 0.1$ .

Table 14 shows the formula of the measurement accuracy of G, Rs, Q and Rn when  $D \leq 0.1$ .

When  $0.1 < D \leq 0.5$ , multiply the accuracy obtained in Tables 8 through 13 by the coefficient in Table 5.

Table 5. Dissipation factor Coefficient

Parameter	Coefficient
Cp, Cs, G, Rs <sup>2</sup>	$1 + D^2$
D	$1 + D$

Table 6. Formula of the measurement accuracy of G, R<sub>s</sub>, Q and R<sub>p</sub>

Parameter	Formula
G <sub>e</sub> (G accuracy)	$(C_e/100) \times 2 \times \pi \times f \times C_x$
Rs <sub>e</sub> (R <sub>s</sub> accuracy)	$(C_e/100) / (2 \times \pi \times f \times C_x)$
Q <sub>e</sub> (Q accuracy)	$\frac{\pm Q_x^2 \times De}{1 \mp Q_x \times De}$
Rp <sub>e</sub> (Rp accuracy)	$\frac{\pm R_{px}^2 \times Ge}{1 \mp R_{px} \times Ge}$

C<sub>e</sub>: Cp or Cs accuracy [%]

f: Measurement frequency [Hz]

C<sub>x</sub>: Measurement value of Cp or Cs [F]

Q<sub>x</sub>: Measurement value of Q

R<sub>px</sub>: Measurement value of Rp [ $\Omega$ ]

De: D accuracy [%]

1. The outer conductor resistance of cable requires the following condition.  
16048A/B: 62 m $\Omega$  or below  
16048D: 90 m $\Omega$  or below
2. If you select a secondary measurement parameter other than D, calculate D.

Accuracy when ambient temperature exceeds the range of 18 to 28°C (typical)

When the ambient temperature exceeds the range of 18 to 28°C, multiply the accuracy obtained above by the coefficient shown in the table below.

Table 7. Temperature Coefficient

	<b>Coefficient</b>
0°C ≤ ambient temperature < 8°C	3
8°C ≤ ambient temperature < 18°C	2
18°C ≤ ambient temperature ≤ 28°C	1
28°C ≤ ambient temperature ≤ 38°C	2
38°C ≤ ambient temperature ≤ 45°C	3

Accuracy when an Alternative Current magnetic field is applied

When an alternating current magnetic field is applied to the instrument. Multiply the accuracy obtained in Tables 8 through 13.

$$1+B \times (2+0.5 \times K)$$

B: Magnetic flux density [Gauss]

Cx: Measured value of the capacitance (Cp or Cs),

Cr: A measurement range [F]

Vs: A measurement signal level [V].

In Tables 8 through 13, K is defined as follows:

$$Cx \leq Cr: K = (1/Vs) \times (Cr/Cx)$$

$$Cx > Cr: K = 1/Vs$$

where

Cx is measured value of the capacitance (Cp or Cs),

Cr is a measurement range and

Vs is a measurement signal level [V].

## Measurement accuracy (continued)

Table 8. Measurement accuracy of Cp, Cs (measurement frequency: 120 Hz)

Measurement time mode (N)	Cp, Cs [%]				
	1	2	4	6	8
10 nF					
22 nF					
47 nF					
100 nF					
220 nF					
470 nF					
1 μF	$0.055 + 0.030 \times K$	$0.055 + 0.022 \times K$	$0.055 + 0.018 \times K$	$0.055 + 0.016 \times K$	$0.055 + 0.015 \times K$
2.2 μF					
4.7 μF					
10 μF					
22 μF					
47 μF					
100 μF					
220 μF					
470 μF	$0.4 + 0.060 \times K$	$0.4 + 0.044 \times K$	$0.4 + 0.036 \times K$	$0.4 + 0.032 \times K$	$0.4 + 0.030 \times K$
1 mF					

Table 9. Measurement accuracy of D (measurement frequency: 120 Hz)

Measurement time mode (N)	D				
	1	2	4	6	8
10 nF					
22 nF					
47 nF					
100 nF					
220 nF					
470 nF					
1 μF	$0.00035 + 0.00030 \times K$	$0.00035 + 0.00022 \times K$	$0.00035 + 0.00018 \times K$	$0.00035 + 0.00016 \times K$	$0.00035 + 0.00015 \times K$
2.2 μF					
4.7 μF					
10 μF					
22 μF					
47 μF					
100 μF					
220 μF					
470 μF	$0.004 + 0.00060 \times K$	$0.004 + 0.00044 \times K$	$0.004 + 0.00036 \times K$	$0.004 + 0.00032 \times K$	$0.004 + 0.00030 \times K$
1 mF					

## Measurement accuracy (continued)

Table 10. Measurement accuracy of Cp, Cs (measurement frequency: 1 kHz)  
Cp, Cs [%]

Measurement time mode (N)	1	2	4	6	8
100 pF	$0.055 + 0.070 \times K$	$0.055 + 0.047 \times K$	$0.055 + 0.036 \times K$	$0.055 + 0.033 \times K$	$0.055 + 0.030 \times K$
220 pF	$0.055 + 0.045 \times K$	$0.055 + 0.032 \times K$	$0.055 + 0.025 \times K$	$0.055 + 0.022 \times K$	$0.055 + 0.020 \times K$
470 pF 1 nF 2.2 nF 4.7 nF 10 nF 22 nF 47 nF 100 nF 220 nF 470 nF 1 μF 2.2 μF 4.7 μF 10 μF	$0.055 + 0.030 \times K$	$0.055 + 0.022 \times K$	$0.055 + 0.018 \times K$	$0.055 + 0.016 \times K$	$0.055 + 0.015 \times K$
22 μF 47 μF 100 μF	$0.4 + 0.060 \times K$	$0.4 + 0.044 \times K$	$0.4 + 0.036 \times K$	$0.4 + 0.032 \times K$	$0.4 + 0.030 \times K$

Table 11. Measurement accuracy of D (measurement frequency: 1 kHz)  
D

Measurement time mode (N)	1	2	4	6	8
100 pF	$0.00035 + 0.00070 \times K$	$0.00035 + 0.00047 \times K$	$0.00035 + 0.00036 \times K$	$0.00035 + 0.00033 \times K$	$0.00035 + 0.00030 \times K$
220 pF	$0.00035 + 0.00045 \times K$	$0.00035 + 0.00032 \times K$	$0.00035 + 0.00025 \times K$	$0.00035 + 0.00022 \times K$	$0.00035 + 0.00020 \times K$
470 pF 1 nF 2.2 nF 4.7 nF 10 nF 22 nF 47 nF 100 nF 220 nF 470 nF 1 μF 2.2 μF 4.7 μF 10 μF	$0.00035 + 0.00030 \times K$	$0.00035 + 0.00022 \times K$	$0.00035 + 0.00018 \times K$	$0.00035 + 0.00016 \times K$	$0.00035 + 0.00015 \times K$
22 μF 47 μF 100 μF	$0.004 + 0.00060 \times K$	$0.004 + 0.00044 \times K$	$0.004 + 0.00036 \times K$	$0.004 + 0.00032 \times K$	$0.004 + 0.00030 \times K$

## Measurement accuracy (continued)

Table 12. Measurement accuracy of Cp, Cs (measurement frequency: 1 MHz, 1 MHz ± 1%, 1 MHz ± 2%)

Measurement time mode (N)	Cp, Cs [%]				
	1	2	4	6	8
1 pF	$0.055 + 0.070 \times K$	$0.055 + 0.047 \times K$	$0.055 + 0.036 \times K$	$0.055 + 0.033 \times K$	$0.055 + 0.030 \times K$
2.2 pF	$0.055 + 0.045 \times K$	$0.055 + 0.032 \times K$	$0.055 + 0.025 \times K$	$0.055 + 0.022 \times K$	$0.055 + 0.020 \times K$
4.7 pF	$0.055 + 0.030 \times K$	$0.055 + 0.022 \times K$	$0.055 + 0.018 \times K$	$0.055 + 0.016 \times K$	$0.055 + 0.015 \times K$
10 pF					
22 pF					
47 pF					
100 pF					
220 pF					
470 pF					
1 nF					

Table 13. Measurement accuracy of D (measurement frequency: 1 MHz, 1 MHz ± 1%, 1 MHz ± 2%)

Measurement time mode (N)	D				
	1	2	4	6	8
1 pF	$0.00035 + 0.00070 \times K$	$0.00035 + 0.00047 \times K$	$0.00035 + 0.00036 \times K$	$0.00035 + 0.00033 \times K$	$0.00035 + 0.00030 \times K$
2.2 pF	$0.00035 + 0.00045 \times K$	$0.00035 + 0.00032 \times K$	$0.00035 + 0.00025 \times K$	$0.00035 + 0.00022 \times K$	$0.00035 + 0.00020 \times K$
4.7 pF	$0.00035 + 0.00030 \times K$	$0.00035 + 0.00022 \times K$	$0.00035 + 0.00018 \times K$	$0.00035 + 0.00016 \times K$	$0.00035 + 0.00015 \times K$
10 pF					
22 pF					
47 pF					
100 pF					
220 pF					
470 pF					
1 nF					

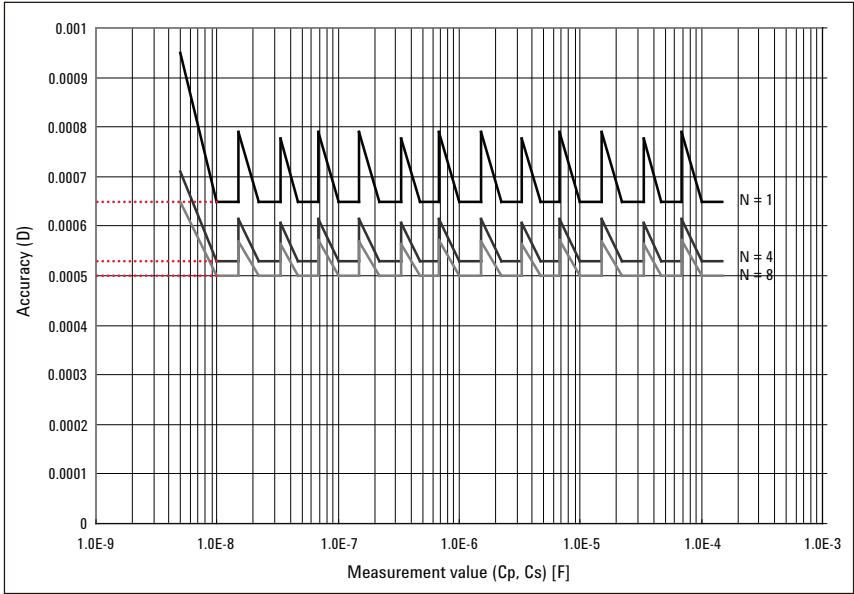

Figure 1. Accuracy of D when measurement frequency is 120 Hz  
 (measurement range: 10 nF to 100  $\mu$ F / measurement signal level: 0.5 V)

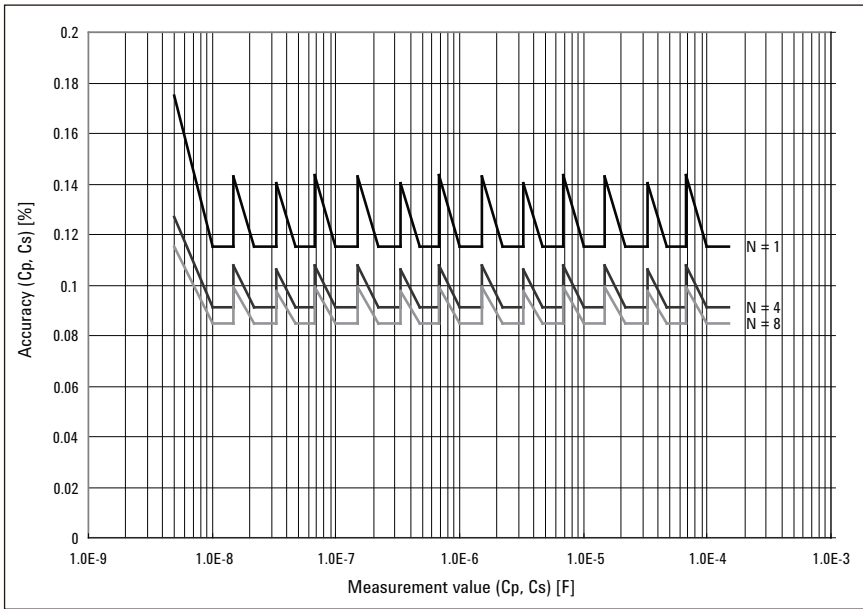

Figure 2. Accuracy of Cp and Cs when measurement frequency is 120 Hz  
 (measurement range: 10 nF to 100  $\mu$ F / measurement signal level: 0.5 V)

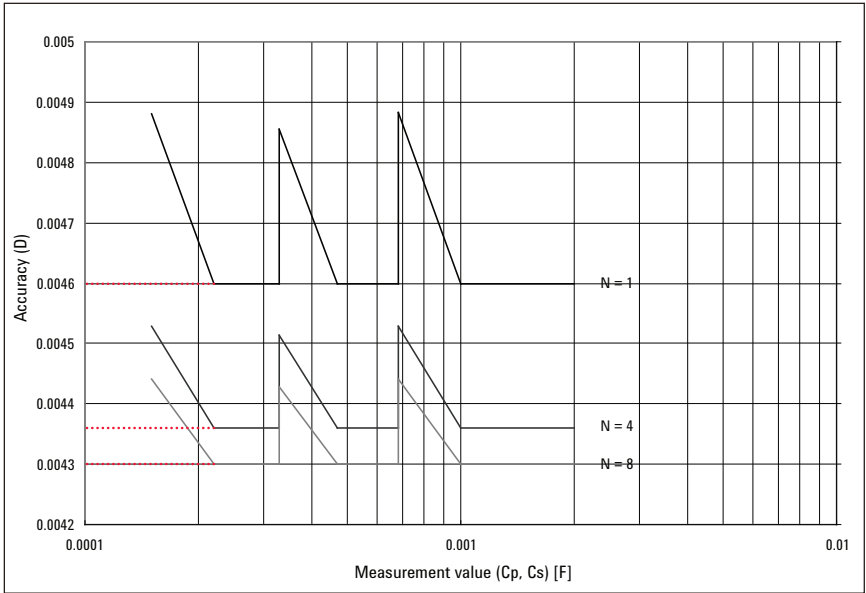

Figure 3. Accuracy of D when measurement frequency is 120 Hz  
(measurement range: 220  $\mu$ F to 1 mF / measurement signal level: 1 V)

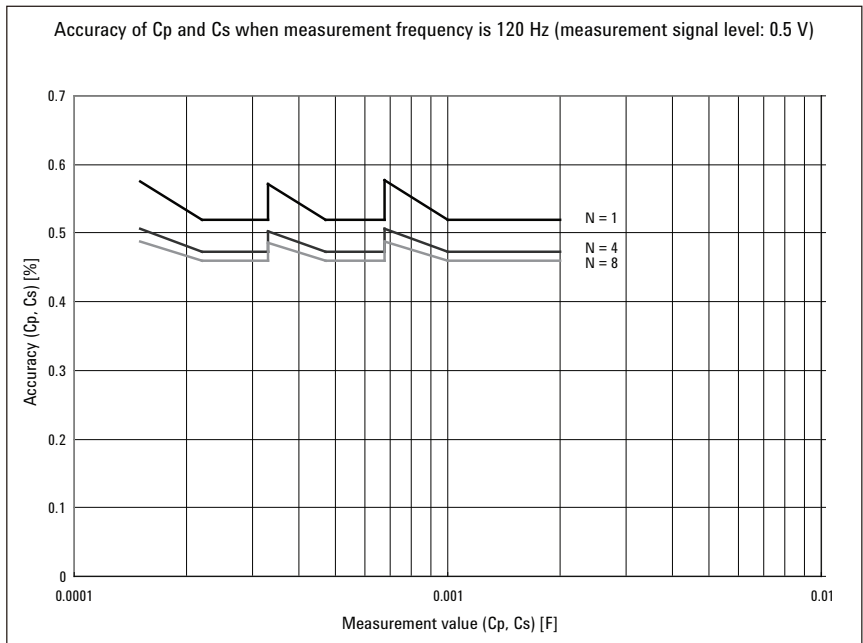

Figure 4. Accuracy of Cp and Cs when measurement frequency is 120 Hz  
(measurement range: 220  $\mu$ F to 1 mF / measurement signal level: 1 V)



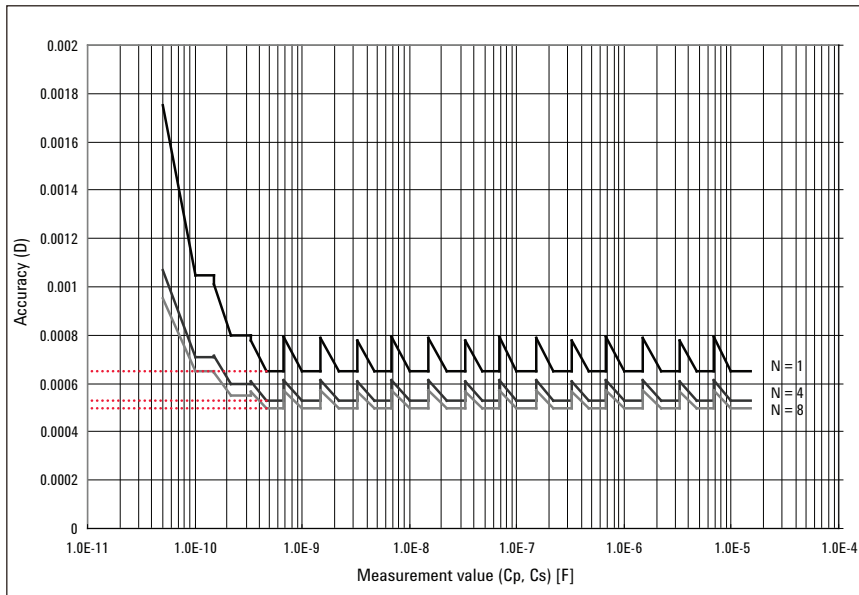

Figure 5. Accuracy of D when measurement frequency is 1 kHz  
(measurement range: 100 pF to 10  $\mu$ F / measurement signal level: 1 V)

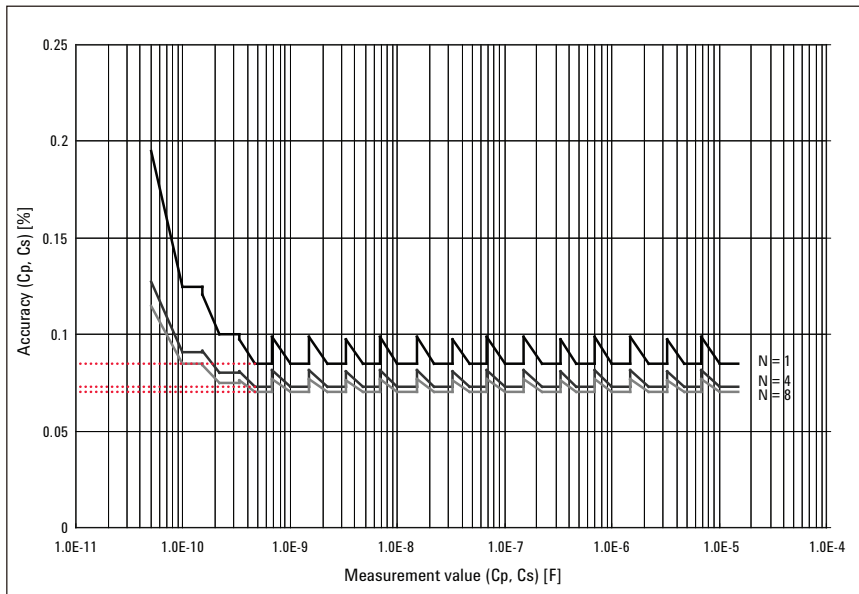

Figure 6. Accuracy of Cp and Cs when measurement frequency is 1 kHz  
(measurement range: 100 pF to 10  $\mu$ F / measurement signal level: 1 V)

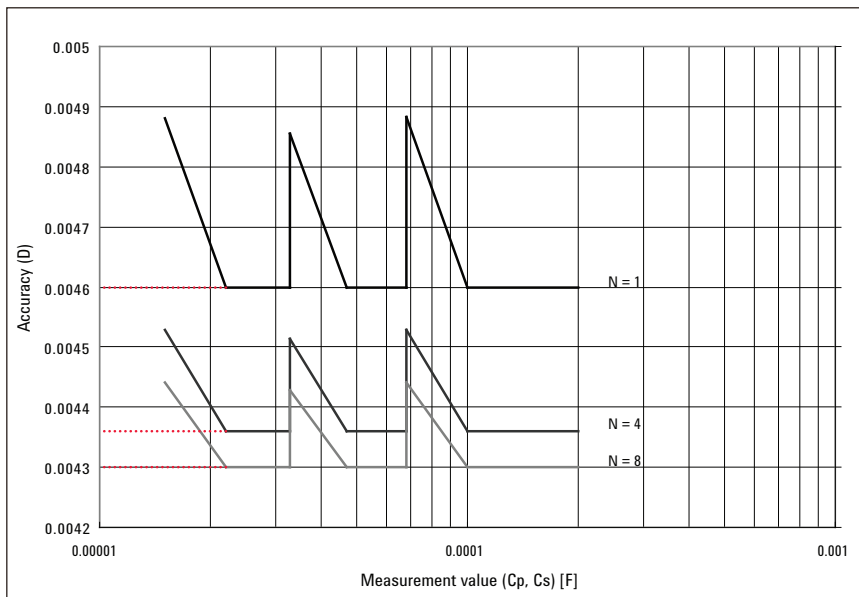

Figure 7. Accuracy of D when measurement frequency is 1 kHz  
(measurement range: 22  $\mu$ F to 100  $\mu$ F / measurement signal level: 1 V)

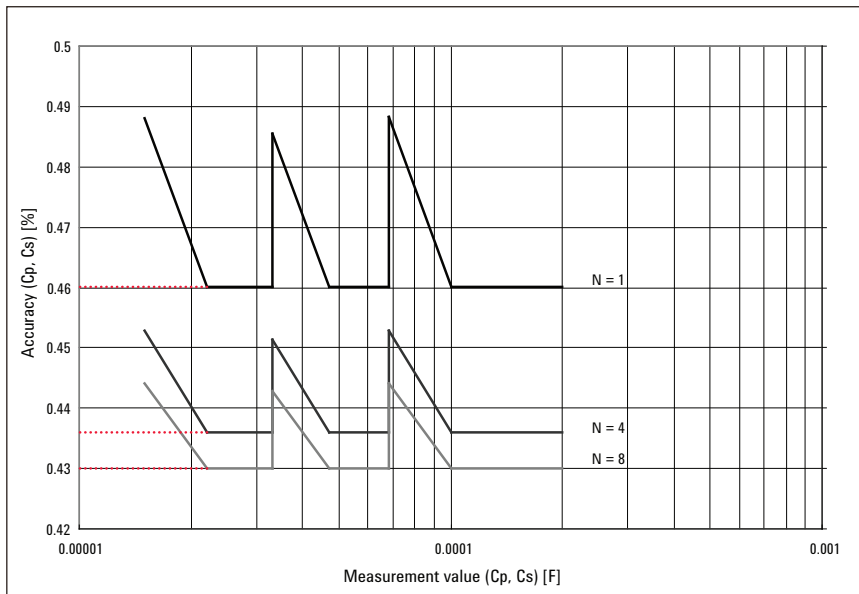

Figure 8. Accuracy of Cp and Cs when measurement frequency is 1 kHz  
(measurement range: 22  $\mu$ F to 100  $\mu$ F / measurement signal level: 1 V)

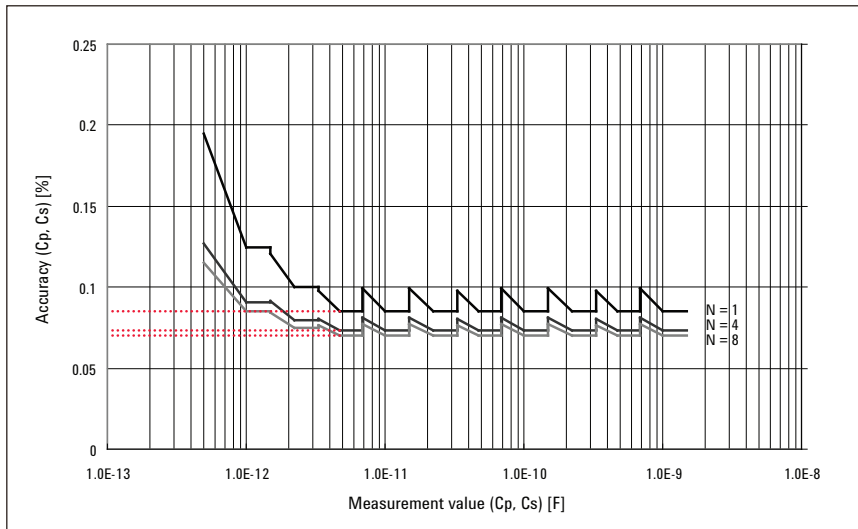

Figure 9. Accuracy of Cp and Cs when measurement frequency is 1 MHz (measurement signal level: 1 V)

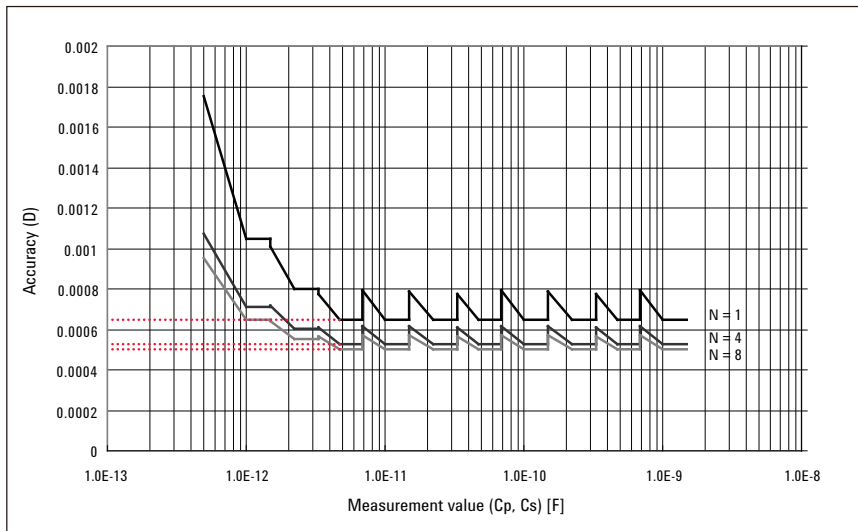

Figure 10. Accuracy of D when measurement frequency is 1 MHz (measurement signal level: 1 V)

Sample calculation of measurement accuracy is described on page 31.

## Supplemental Information

### Measurement signals

	Frequency: 120 Hz	SLC OFF ( $\geq 220 \mu\text{F}$ range)	1.5 $\Omega$ (nom.) <sup>1</sup>
		SLC ON ( $\geq 220 \mu\text{F}$ range)	0.3 $\Omega$ (nom.) <sup>1</sup>
		2.2 $\mu\text{F}$ to 100 $\mu\text{F}$ range	0.3 $\Omega$ (nom.) <sup>1</sup>
		10 nF to 1 $\mu\text{F}$ range	20 $\Omega$ (nom.) <sup>1</sup>
Output impedance	Frequency: 1 kHz	SLC OFF ( $\geq 22 \mu\text{F}$ range)	1.5 $\Omega$ (nom.) <sup>1</sup>
		SLC ON ( $\geq 22 \mu\text{F}$ range)	0.5 $\Omega$ (nom.) <sup>1</sup>
		220 nF to 10 $\mu\text{F}$ range	0.3 $\Omega$ (nom.) <sup>1</sup>
		100 pF to 100 nF range	20 $\Omega$ (nom.) <sup>1</sup>
	Frequency: 1 MHz / 1 MHz $\pm$ 2% / 1 MHz $\pm$ 1%		20 $\Omega$ (nom.) <sup>1</sup>

### Measurement time

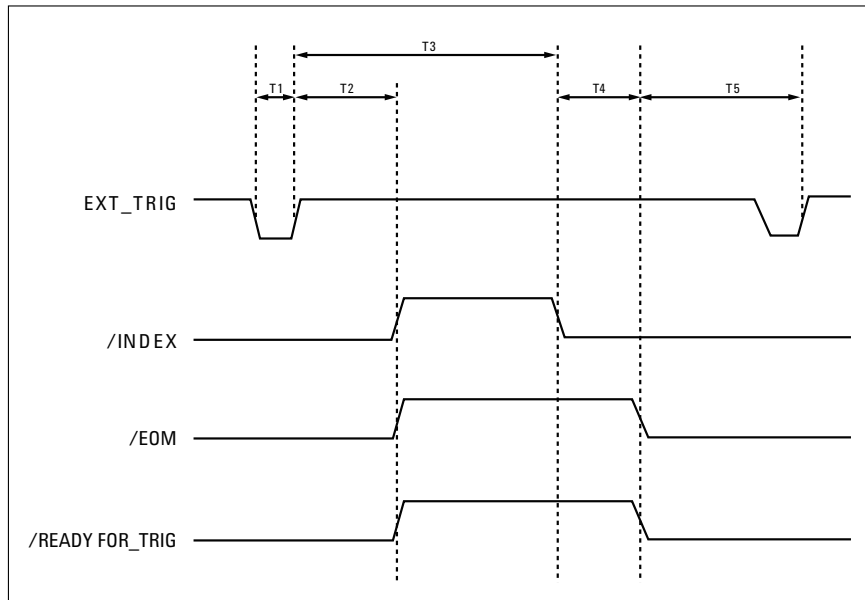

Figure 11. Timing chart and measurement time

1. This value is defined without an extension cable.

Table 14 shows the values of T1 – T5 when the following conditions are met:

- Display update: Off
- Synchronous source: On
- Measurement range mode: Hold range mode (Hold)
- Source delay time: 0 ms
- Trigger delay time: 0 ms
- Averaging factor: 1
- SLC: Off
- Measurement time mode (N): 1
- Correction: On
- Multi connection: On
- LAN: Not connected

Table 14. Values of T1 – T5 (typical)

		Measurement frequency	Minimum value	Typical value
T1				
Trigger pulse width		N/A	1 $\mu$ s	-
T2				
Trigger response time of /READY_FOR_TRIG, /INDEX and /EOM		N/A	-	40 $\mu$ s
(T3 + T4)	T3			
Measurement time	Analog	120 Hz	-	10.0 ms
	measurement	1 kHz	-	2.0 ms
	time	1 MHz	-	1.3 ms
(T3 + T4)	T4			
Measurement time	Measurement computation time	N/A	-	1.0 ms
T5				
Trigger wait time		N/A	0 $\mu$ Sec	-

## Display time

Except in the case of the DISPLAY BLANK page, the time required to update the display on each page (display time) is as follows (Table 15). When the screen is changed, drawing time and switching time are added. The measurement display is updated about every 100 ms.

Table 15. Display time

Item	Time
MEAS DISPLAY page drawing time	10 ms
MEAS DISPLAY page (large) drawing time	10 ms
BIN No. DISPLAY page drawing time	10 ms
BIN COUNT DISPLAY page drawing time	10 ms
Measurement display switching time	35 ms

Table 16 shows the measurement time (T3 + T4) for each measurement time mode.

## Measurement time

Table 16. Measurement time

Frequency	Measurement time [ms]
120 Hz	$(N \times 8.3 \times Ave + 2.7) \pm 0.5$
1 kHz	$(N \times 1.0 \times Ave + 2.0) \pm 0.5$
1 MHz / 1 MHz $\pm$ 1% / 1 MHz $\pm$ 2%	$(N \times 1.0 \times (100/(100 + Fshift)) \times Ave + 1.3) \pm 0.5$

Measurement time mode (N) = 1, 2, 4, 6, 8

Ave: Averaging factor

Fshift: Frequency shift setting

## Measurement data transfer time

Table 17 shows the measurement data transfer time under the following conditions. The measurement transfer time varies with the measurement conditions and computer used.

- Host computer: DELL PRECISION 390, 1.86 GHz/Windows XP
- USB GPIB Interface Card: 82350A
- USB GPIB Interface: E2078A
- Display: ON
- Measurement range mode: Hold range mode (Hold)
- OPEN/SHORT/LOAD correction: OFF
- Measurement signal monitor: OFF
- BIN count function: OFF

Table 17. Measurement data transfer time (typical)

Interface	Data transfer format	using: FETC? command (one point measurement)		using: READ command (one point measurement)		using data buffer memory (1000 measurement points (BUFFER3))	
		Comparator ON [ms]	Comparator OFF [ms]	Comparator ON [ms]	Comparator OFF [ms]	Comparator ON [ms]	Comparator OFF [ms]
GPIB	ASCII	1	1	3	3	202	186
	ASCII Long	1	1	3	3	247	231
	Binary	1	1	3	4	145	111
USB	ASCII	1	1	4	4	101	94
	ASCII Long	1	1	4	4	121	114
	Binary	1	1	4	4	43	33
LAN	ASCII	3	3	5	5	158	146
	ASCII Long	3	3	6	6	193	181
	Binary	5	5	7	7	105	79

# Measurement Assistance Functions

## Measurement assistance functions

Correction function	<ul style="list-style-type: none"> <li>– OPEN/SHORT/LOAD Correction are available</li> <li>– The OFFSET Correction is available</li> </ul>
MULTI Correction function	<ul style="list-style-type: none"> <li>– OPEN/SHORT/LOAD Correction for 256 channels</li> <li>– The LOAD Correction standard value can be defined for each channel</li> </ul>
Cable Correction function	Cable Correction is available
Deviation measurement function	Deviation from reference value and percentage of deviation from the reference value can be outputted as the result
Comparator function	<ul style="list-style-type: none"> <li>– BIN sort: The primary parameter can be sorted into 9 BINS, OUT_OF_BINS, AUX_BIN, and LOWC_OR_NC. The secondary parameter can be sorted into High, In, and Low.</li> <li>– Limit setup: An absolute value, deviation value, and % deviation value can be used for setup</li> <li>– Bin count: Countable from 0 to 999999</li> </ul>
Low C reject function	Extremely low measured capacitance values can be automatically detected as measurement errors
Contact check function	The contact check function is available on 120 Hz and 1 kHz
Single Level Compensation	<ul style="list-style-type: none"> <li>– SLC function compensates the voltage drop by the resistance inside the E4981A and the extension cable under the following frequencies and ranges</li> <li>– Measurement cable: 16048A or 16048D</li> <li>– When the measurement frequency is 120 Hz: 220 <math>\mu</math>F range, 470 <math>\mu</math>F range, 1 mF range</li> <li>– When the measurement frequency is 1 kHz: 22 <math>\mu</math>F range, 47 <math>\mu</math>F range, 100 <math>\mu</math>F range</li> </ul>

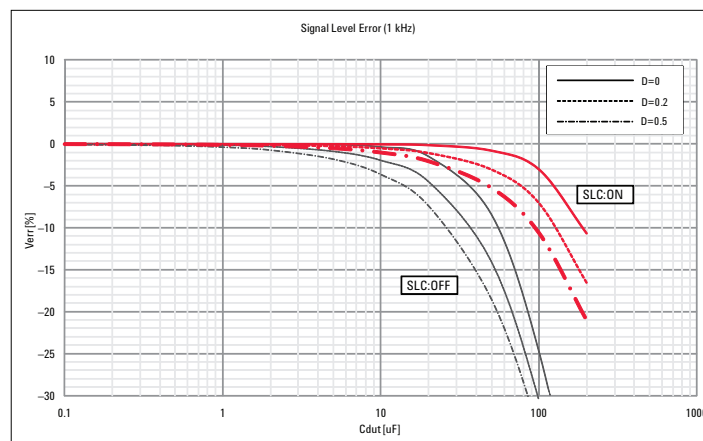
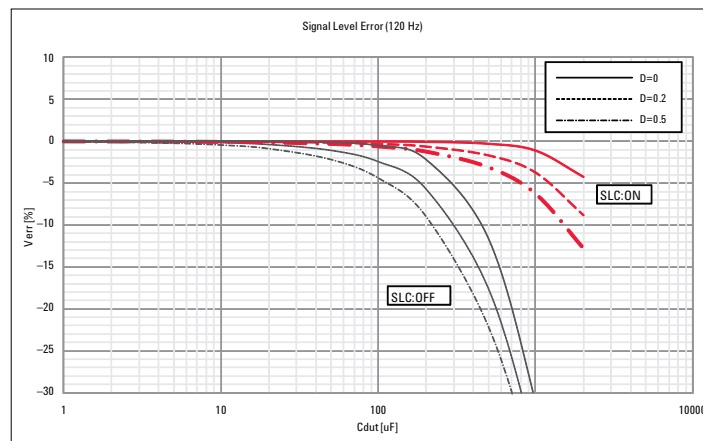



## Measurement assistance functions

Measurement signal level monitor function	<ul style="list-style-type: none"> <li>– Measurement voltage and measurement current can be monitored</li> <li>– Level monitor accuracy (typical): <math>\pm (3\% + 1 \text{ mV})</math></li> </ul>
Data buffer function	Up to 1000 measurement results can be read out in batch
Save/recall function	<ul style="list-style-type: none"> <li>– Up to 10 setup conditions can be written to/read from the built-in nonvolatile memory</li> <li>– Up to 10 setup conditions can be written to/read from the external USB memory</li> <li>– Auto recall function can be performed when the setting conditions are written to Register 9 in the built-in non-volatile memory</li> </ul>
Key lock function	The front panel keys can be locked
GPIB interface	Complies with IEEE488.1, 2 and SCPI
USB host port	<p>Universal serial bus jack, type-A (4 contact positions, contact 1 is on your left); female; for connection to USB memory device only</p> <p>Note: The following USB memory can be used.</p> <ul style="list-style-type: none"> <li>– Complies with USB 1.1; mass storage class, FAT16/FAT32 format; maximum consumption current is below 500 mA</li> <li>– Recommended USB memory: 4 GB USB Flash memory (Keysight PN 1819-0637)</li> <li>– Use the prepared USB memory device exclusively for the E4981A; otherwise, other previously saved data may be cleared. If you use a USB memory other than the recommended device, data may not be saved or recalled normally.</li> <li>– Keysight will NOT be responsible for data loss in the USB memory caused by using the E4981A</li> </ul>
USB interface port	<ul style="list-style-type: none"> <li>– Universal serial bus jack, type mini-B (4 contact positions); complies with USBTMC-USB488 and USB 2.0; female; for connection to the external controller.</li> <li>– USBTMC: Abbreviation for USB Test &amp; Measurement Class</li> </ul>
LAN interface	<ul style="list-style-type: none"> <li>– 10/100 BaseT Ethernet, 8 pins; two speed options</li> <li>– Compliant with LXI standard (LAN eXtensions for Instrumentation): Version 1.2, Class C</li> <li>– Auto MDIX</li> </ul>
Handler interface	<p>The input/output signals are negative logic and optically isolated open collector signals</p> <ul style="list-style-type: none"> <li>– Output signal: Bin1–Bin9, Out of Bins, Aux Bin, P-Hi, P-Lo, S-Reject, INDEX, EOM, Alarm, OVLD, Low C Reject or No Contact, Ready_For_Trigger</li> <li>– Input signal: Keylock, Ext-Trigger</li> </ul>
Scanner interface	<p>The input/output signals are negative logic and optically isolated open collector signals</p> <ul style="list-style-type: none"> <li>– Output signal: INDEX, EOM</li> <li>– Input signal: Ch0 – Ch7, Ch valid, Ext-Trigger</li> </ul>
Measurement circuit protection	<p>The maximum discharge withstand voltage, where the internal circuit remains protected if a charged capacitor is connected to the UNKNOWN terminal, is illustrated below.</p> <p>NOTE: Discharge capacitors before connecting them to the UNKNOWN terminal or a test fixture.</p>

Table 18. Maximum discharge withstand voltage (typical)

Maximum discharge withstand voltage	Range of capacitance value C of DUT
1000 V	$C < 2 \mu\text{F}$
$\sqrt{2/C} \text{ V}$	$C \geq 2 \mu\text{F}$

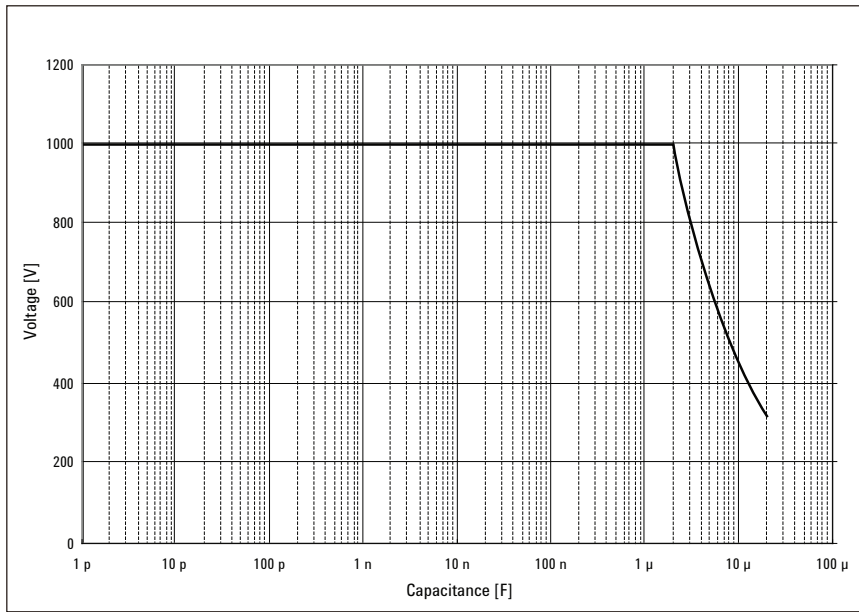

Figure 13. Maximum discharge withstand voltage (typical)

## General Specifications

Power source	
Voltage	90 VAC to 264 VAC
Frequency	47 Hz to 63 Hz
Power consumption	Maximum 150 VA

Operating environment	
Temperature	0 °C to 45 °C
Humidity ( $\leq 40$ °C, no condensation)	15% to 85% RH
Altitude	0 m to 2000 m

Storage environment	
Temperature	-20 °C to 70 °C
Humidity ( $\leq 65$ °C, no condensation)	0% to 90% RH
Altitude	0 m to 4572 m

Other	
Weight	4.3 kg (nominal)
Display	LCD, 320 x 240 (pixel), RGB color
Outer dimensions	370 (width) x 105 (height) x 405 (depth) mm (nominal)

Note:  
Effective pixels are more than 99.99%. There may be 0.01% or smaller missing pixels or constantly lit pixels, but this is not a malfunction.

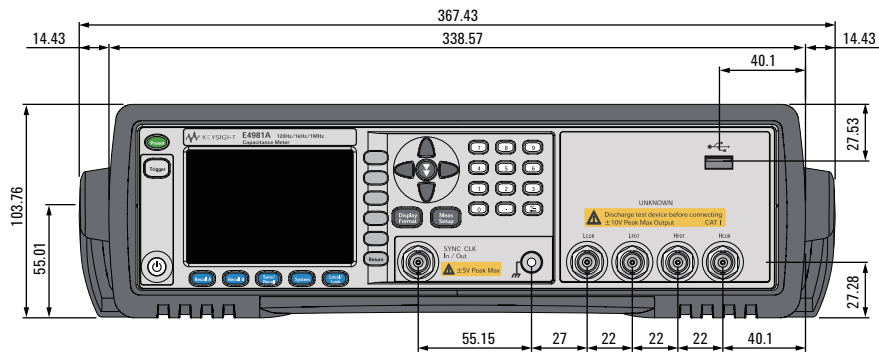

Figure 14. Dimensions (front view, with handle and bumper, in millimeters, nominal)

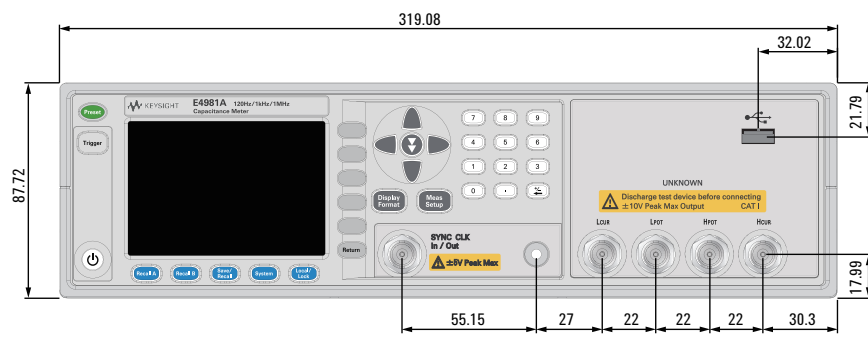

Figure 15. Dimensions (front view, without handle and bumper, in millimeters, nominal)

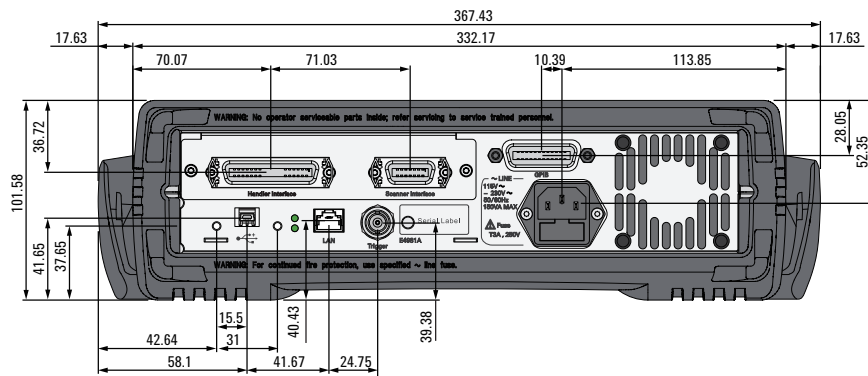

Figure 16. Dimensions (rear view, with handle and bumper, in millimeters, nominal)

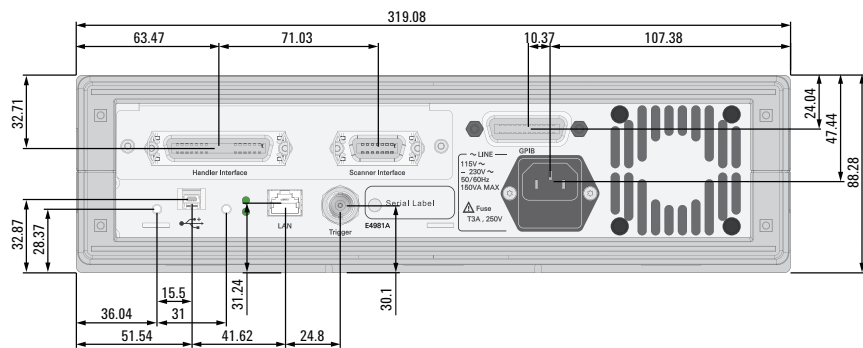

Figure 17. Dimensions (rear view, without handle and bumper, in millimeters, nominal)

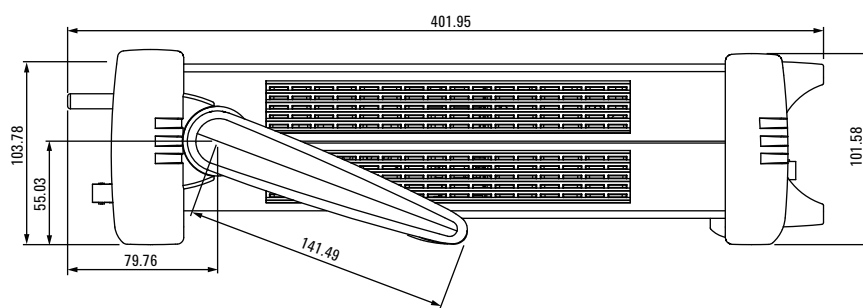

Figure 18. Dimensions (side view, with handle and bumper, in millimeters, nominal)

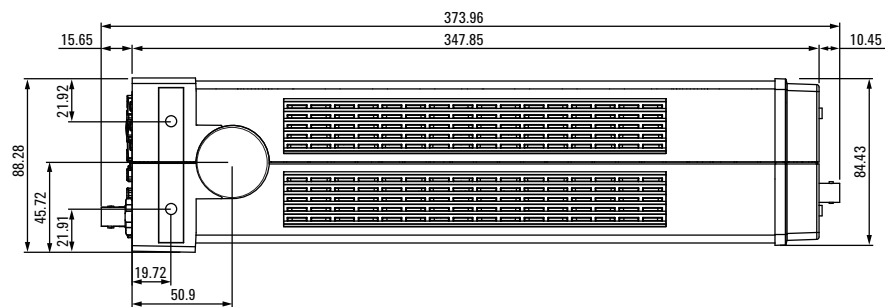









Figure 19. Dimensions (side view, without handle and bumper, in millimeters, nominal)

## EMC, Safety, Environment and Compliance

Description	Specification
EMC	
 <b>ISM 1-A</b>	<p>European Council Directive 2004/108/EC            IEC 61326-1:2012            EN 61326-1:2013            CISPR 11:2009 +A1:2010            EN 55011: 2009 +A1:2010            Group 1, Class A            IEC 61000-4-2:2008            EN 61000-4-2:2009            4 kV CD / 8 kV AD            IEC 61000-4-3:2006 +A1:2007 +A2:2010            EN 61000-4-3:2006 +A1:2008 +A2:2010            3 V/m, 80-1000 MHz, 1.4 - 2.0 GHz / 1V/m, 2.0 - 2.7 GHz, 80% AM            IEC 61000-4-4:2004 +A1:2010            EN 61000-4-4:2004 +A1:2010            1 kV power lines / 0.5 kV signal lines            IEC 61000-4-5:2005            EN 61000-4-5:2006            0.5 kV line-line / 1 kV line-ground            IEC 61000-4-6:2008            EN 61000-4-6:2009            3 V, 0.15-80 MHz, 80% AM            IEC 61000-4-8:2009            EN 61000-4-8:2010            30A/m, 50/60Hz            IEC 61000-4-11:2004            EN 61000-4-11:2004            0.5-300 cycle, 0% / 70%</p>
	<p><b>Note:</b>            When tested at 3 V/m according to EN61000-4-3, the measurement accuracy will be within specifications over the full immunity test frequency range except when the meter frequency is identical to the transmitted interference signal test frequency (the frequencies around the carrier frequency and frequencies around the modulation frequency).</p>
<b>ICES/NMB-001</b>	ICES-001:2006 Group 1, Class A
	<p>AAS/NZS CISPR11:2004            Group 1, Class A</p>
	<p>KN11, KN61000-6-1 and KN61000-6-2            Group 1, Class A</p>

## EMC, Safety, Environment and Compliance continued

Description	Specification	
<b>Safety</b>		
 <b>ISM 1-A</b>	European Council Directive 73/23/EEC, 93/68/EEC	
	IEC 61010-1:2001 EN 61010-1:2001	Measurement Category I Pollution Degree 2 Indoor Use
	IEC60825-1:1994	Class 1 LED
 <b>LR95111C</b>	CAN/CSA C22.2 61010-1-04	Measurement Category I Pollution Degree 2 Indoor Use
<b>WEEE</b>		
 	European Council Directive 2002/96/EC	

## Sample Calculation of Measurement Accuracy

This section describes an example for calculating the measurement accuracy of each measurement parameter, assuming the following measurement conditions

### Sample

- Measurement signal frequency: 1 kHz
- Measurement signal level: 0.5 V
- Measurement range: 10 nF
- Measurement time mode: N = 1
- Ambient temperature: 28°C

### When measurement parameter is Cp-D (or Cs-D)

The following is an example for calculating the accuracy of Cp (or Cs) and D, assuming that measured result of Cp (or Cs) is 8.00000 nF and measured result of D is 0.01000.

From Table 7, the equation to calculate the accuracy of Cp (or Cs) is

$$0.055 + 0.030 \times K$$

and the equation to calculate the accuracy of D is

$$0.00035 + 0.00030 \times K$$

The measurement signal level is 0.5, the measurement range is 10 nF, and the measured result of Cp (or Cs) is 8.00000 nF. Therefore,

$$K = (1/0.5) \times (10/8.00000) = 2.5$$

Substitute this result into the equation. As a result, the accuracy of Cp (or Cs) is

$$0.055 + 0.030 \times 2.5 = 0.13\%$$

and the accuracy of D is

$$0.00035 + 0.00030 \times 2.5 = 0.0011$$

Therefore, the true Cp (or Cs) value exists within

$$8.00000 \pm (8.00000 \times 0.13/100) = 8.00000 \pm 0.0104 \text{ nF}$$

that is,

$$7.9896 \text{ nF to } 8.0104 \text{ nF}$$

and the true D value exists within

$$0.01000 \pm 0.0011$$

that is,

$$0.0089 \text{ to } 0.0111$$



When measurement parameter is Cp-Q (or Cs-Q)

The following is an example for calculating the accuracy of Cp (or Cs) and Q, assuming that measured result of Cp (or Cs) is 8.00000 nF and measured result of Q is 20.0.

The accuracy of Cp (or Cs) is the same as that in the example of Cp-D.

From Table 8, the equation to calculate the accuracy of D is

$$0.00035 + 0.00030 \times K$$

Substitute  $K = 2.5$  (same as Cp-D) into this equation.

The accuracy of D is

$$0.00035 + 0.00030 \times 2.5 = 0.0011$$

Then, substitute the obtained D accuracy into Equation 1. The accuracy of Q is

$$\pm(20.0)^2 \times 0.0011 / (1 \mp 20.0 \times 0.0011) = \pm 0.44 / (1 \mp 0.022)$$

that is,

$$-0.43 \text{ to } 0.45$$

Therefore, the true Q value exists within the range of

$$19.57 \text{ to } 20.45$$

When measurement parameter is Cp-G

The following is an example for calculating the accuracy of Cp and G, assuming that measured result of Cp is 8.00000 nF and measured result of G is 1.00000  $\mu$ S.

The accuracy of Cp is the same as that in the example of Cp-D.

From Table 6, the equation to calculate the accuracy of G is

$$(C_e/100) \times 2 \times \pi \times f \times C_x$$

Substitute  $C_e = 0.13\%$  (same as Cp-D) and  $C_x = 8.00000$  nF of the measured Cp result into this equation.

The accuracy of G is

$$(0.13/100) \times 2 \times \pi \times 1 \times 10^3 \times 8 \times 10^{-9} = 65.35\text{nS} (0.065\mu\text{S})$$

Therefore, the true G value exists within

$$1.00000 \pm 0.065 \mu\text{S}$$

that is,

$$0.935 \mu\text{S} \text{ to } 1.065 \mu\text{S}$$

When measurement parameter is Cp-Rp

The following is an example for calculating the accuracy of Cp and Rp, assuming that measured result of Cp is 8.00000 nF and measured result of Rp is 2.00000 MΩ.

The accuracy of Cp is the same as that in the example of Cp-D.

From Table 6 the equation to calculate the accuracy of Rp is

$$\frac{\pm R_{px}^2 \times G_e}{1 \mp R_{px} \times G_e}$$

Substitute  $R_{px} = 2.00000 \text{ M}\Omega$  of the measured Rp result into this equation.

The accuracy of G is

$$(0.13/100) \times 2 \times \pi \times 1 \times 10^3 \times 8 \times 10^{-9} = 65.35 \text{ nS} (0.065 \mu\text{S})$$

Then, substitute the obtained G accuracy into 1st Equation. The accuracy of Rp is

$$\frac{\pm 2M^2 \times 0.065 \mu}{1 \mp 2M \times 0.065 \mu}$$

that is,

$$-0.23009 \text{ M}\Omega \text{ to } 0.29885 \text{ M}\Omega$$

Therefore, the true Rp value exists within

$$1.76991 \text{ M}\Omega \text{ to } 2.29885 \text{ M}\Omega$$

When measurement parameter is Cs-Rs

The following is an example for calculating the accuracy of Cs and Rs, assuming that measured result of Cs is 8.00000 nF and measured result of Rs is 4.00000 kΩ.

Because the Cs accuracy is

$$D = 2 \times \pi \times \text{Freq} \times C_s \times R_s = 2 \times \pi \times 1 \times 10^3 \times 8 \times 10^{-9} \times 4 \times 10^3 = 0.2 \quad (0.1 < D \leq 0.5)$$

multiply 0.13% (the result obtained for Cs-D) by  $1 + D^2$ .

The result is

$$0.13 \times (1 + 0.22) = 0.1352\%$$

From Table 6 the equation to calculate the accuracy of Rs is

$$(C_e/100) / (2 \times \pi \times f \times C_x)$$

Substitute  $C_e = 0.1352\%$  (Cs accuracy calculated above) and  $C_x = 8.00000$  nF of the measured Cs result into this equation.

The accuracy of Rs is

$$(0.1352/100) / (2 \times \pi \times 1 \times 10^3 \times 8 \times 10^{-9}) = 26.897$$

Because  $(0.1 < D \leq 0.5)$ , multiply the result by  $1 + D^2$  similar as in the case of Cs. The final result is 27.97 Ω.

Therefore, the true Cs value exists within

$$8.00000 \pm (8.00000 \times 0.1352/100) = 8.00000 \pm 0.01082 \text{ nF}$$

that is,

$$7.98918 \text{ nF to } 8.01082 \text{ nF}$$

and the true Rs value exists within

$$4.00000 \pm 0.02797 \text{ k}\Omega$$

that is,

$$3.97203 \text{ to } 4.02797 \text{ k}\Omega$$